



MANUAL AND USER GUIDE

PERSONAL PA[®] T35 Transmitter

Wireless FM Listening System

Transmitter Model PPA T35
Optional Receiver Models PPA R30, R7, R7-4, R19, R19-6

MANUAL AND USER GUIDE

<i>Contents</i>	<i>Page</i>
SYSTEM OVERVIEW	4
QUICK SETUP INSTRUCTIONS	5
DETAILED INSTALLATION INSTRUCTIONS	6
SELECT A LOCATION	6
INSTALLING THE ANTENNA	6
WIRING AND CONNECTIONS	7
REAR PANEL	7
CONNECTING THE POWER SUPPLY	7
AUDIO SOURCE CONNECTIONS	7
CHOOSING AN AUDIO SOURCE FOR THE HEARING IMPAIRED	8
AVOIDING GROUND LOOPS	9
CONNECTING TO A RECORDING DEVICE	9
CONTROLS AND FEATURES	10
FRONT PANEL CONTROLS	10
LCD SCREEN MENUS	12
APPLICATION PRESETS	13
BANDWIDTH	14
FREQUENCY	14
AUDIO SOURCE	15
HIGH PASS FILTER	15
LOW PASS FILTER	16
COMPRESSOR SLOPE	16
COMPRESSOR GAIN	17
RF OUTPUT	18
RECEIVER INSTRUCTIONS	19
WIDEBAND OPTIONS	19
FREQUENCY CHANGE INSTRUCTIONS	21
NARROWBAND OPTIONS	22
RECEIVER MANAGEMENT	24
BATTERY INFORMATION	24
TROUBLE-SHOOTING GUIDE	25
WARRANTY	27
SYSTEM SPECIFICATIONS	28

SYSTEM OVERVIEW

The PPA T35 is an FM Wide-band / Narrow-Band transmitter which operates in the 72-76 MHz frequency bandwidth. It is designed to be used with battery powered FM receivers: Compatible Williams Sound receivers include the R30, R7, R7-4 (Wide-Band), and the R19 and R19-6 (Narrow-band). Please contact Williams Sound Corp. for more information on available receivers: 800-843-3544. Or, visit us on the web: www.williamssound.com.

Developed for hearing assistance in places of public access, the PPA T35 is designed for those who need help overcoming background noise, reverberation, or distance from the sound source. It includes a complete audio processor optimized for the needs of hearing impaired persons and is easily integrated with your existing sound system. The PPA T35 can also be used with a microphone as a stand-alone system.

Your PPA T35 transmitter operates much like an FM radio station. The transmitter picks up the live audio directly from a microphone or sound system. Those sounds are then broadcasted over an FM radio signal. FM receivers are worn by the listener. The broadcast can be picked up from up to 500 feet away*. This allows the listener to sit anywhere in the audience and listen to the broadcast as loud as needed without disturbing anyone else.

Please read through this manual carefully. It includes important setup procedures and guidelines for proper operation. If at any time you are having problems with this product, please contact Williams Sound toll free for assistance: 800-843-3544.

NOTE: FCC regulations, section 15.21, requires the user to comply with the rules of transmitter operation. Any changes or modifications made by the user not expressly approved for compliance may result in the loss of all privileges and authority to operate the equipment.

FIGURE 1: OVERALL SYSTEM DIAGRAM

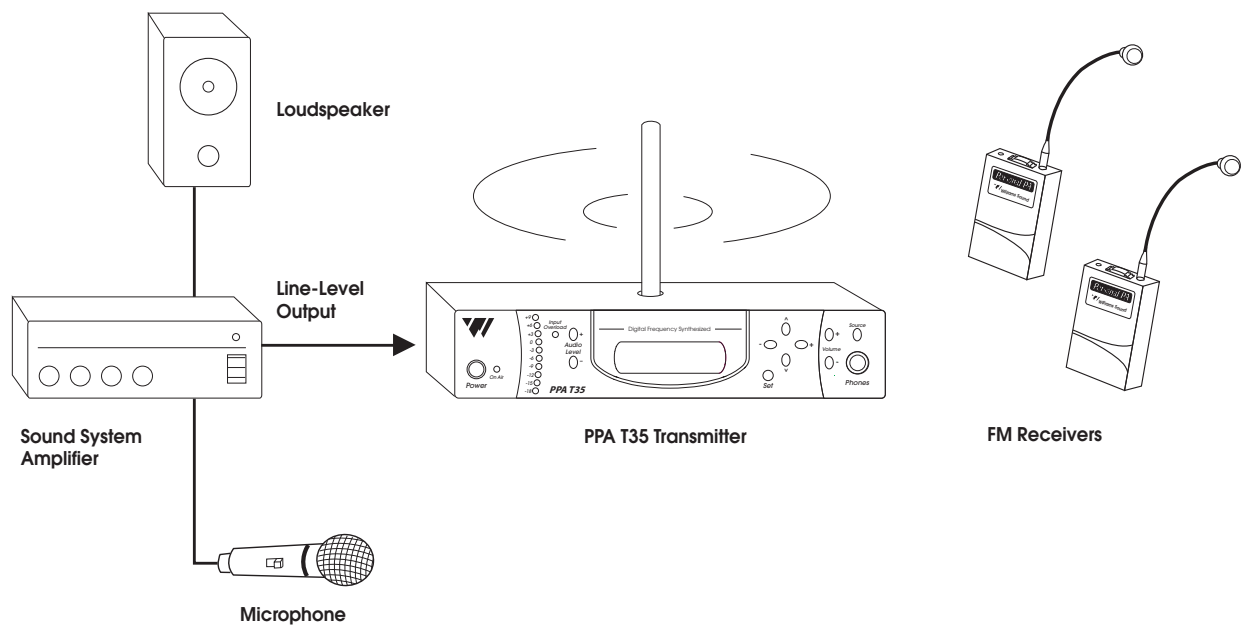

*Range may be affected by metal structures. 500+ feet is the maximum operating range of the T35

QUICK SETUP INSTRUCTIONS

- STEP 1:** Position the PPA T35 transmitter near the sound system or mixer from which it will receive audio.
- STEP 2:** Install the ANT 021 "rubber duckie" antenna. Gently thread the ANT 021 onto the stud recessed in the hole on the top of the transmitter.
- STEP 3:** Connect the power supply to the "Power In" connector (Figure 5) located in the back of the T35. Press in the power button on the front of the T35. The "On Air" green LED indicator should illuminate. If not, go back and check the power connections.
- STEP 4:** Select an application. The T35 has *three* pre-configured Application Presets to choose from: **Hearing Assist, Music and Voice**. The performance of the T35 is optimized for each selected application. Using the menu control buttons on the front of the T35 (Figure 2), press the "v" button to access the "Application Presets" LCD screen. Press the "+" and "-" menu buttons to alternate between Hearing Assist, Music and Voice selection. When the desired Application Preset is displayed, press the "Set" button to save the change into memory.
- STEP 5:** The T35 is shipped from the factory in wideband mode with the frequency set to 72.900 MHz. To change the frequency or bandwidth on the T35, refer to the instructions on page 14.
- STEP 6:** Configure the T35 for the appropriate audio source. Using the menu control buttons on the front of the T35 (Figure 2), press the "v" button to access the "Audio Source" LCD screen. Using the "+" and "-" menu buttons (Figure 2), choose between MIC, SIMPLEX-MIC, or LINE. When the desired audio input is displayed, press the "Set" button to save the change into memory. Lastly, connect the audio source to the audio input jack in the rear of the T35 transmitter.
- STEP 7:** With the audio source playing, adjust the Audio Level control on the T35 so that the green "0 dB" LED generally lights and the red "+9 dB" LED lights occasionally; Press the Audio Level "+" button to increase the audio level in .5dB steps. Press the Audio Level "-" button to decrease the audio level in .5dB steps. See Figure 3.
- STEP 8:** Listen with an FM receiver (see pages 19-23 for compatible Williams Sound receivers). Install the batteries, plug in the earphone, turn on the receiver and walk around the listening area. The signal should be clear and quite loud when the volume is turned up.

IMPORTANT: The FM receiver being used with the T35 transmitter will need to be on the same frequency and bandwidth as the transmitter. To retune the receiver, see page 21.

Please read through this manual carefully for detailed instructions and setup procedures.

FIG. 2: LCD Menu Controls

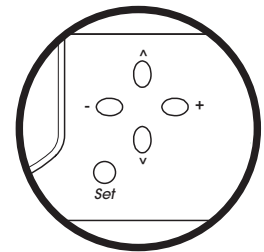

Front panel of the T35

FIG. 3: Audio Input Controls

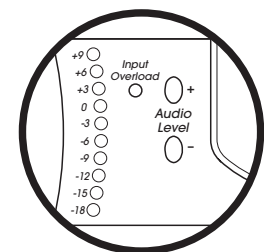

Front panel of the T35

SETTING UP THE T35 - DETAILED INSTRUCTIONS

▶ SELECT A LOCATION

The transmitter is usually located near the sound system amplifier or mixer for easy access to an audio output signal. Position the transmitter on a level surface. It should be free from metallic objects that might interfere with the antenna signal.

For permanent installation, the PPA T35 transmitter can be rack mounted. Use the Williams Sound RPK 005 or RPK 006 rack mount kits. Make sure there is good electrical contact between the transmitter chassis and the rack cabinet.

▶ INSTALL THE ANT 021 ANTENNA

NOTE: If the T35 is going to be rack mounted, you will not be able to install the ANT 021 "Rubber Duckie." For rack mounting, consider installing a remote antenna (see following section).

The PPA T35 is shipped with a flexible antenna (ANT 021). The ANT 021 threads onto a stud recessed in a hole on the top the transmitter. Screw the antenna clockwise until the connection is secure (Figure 4). Do not use excessive force to tighten the antenna. For operating the T35 in remote locations, a coaxial antenna (ANT 005) or Wall Mount Dipole antenna (ANT 024) can be installed. The external antenna jack is located at the rear of the T35 transmitter (Figure 4). The external antenna impedance is 75 ohms.

FIG. 4:
INSTALLING THE ANTENNA

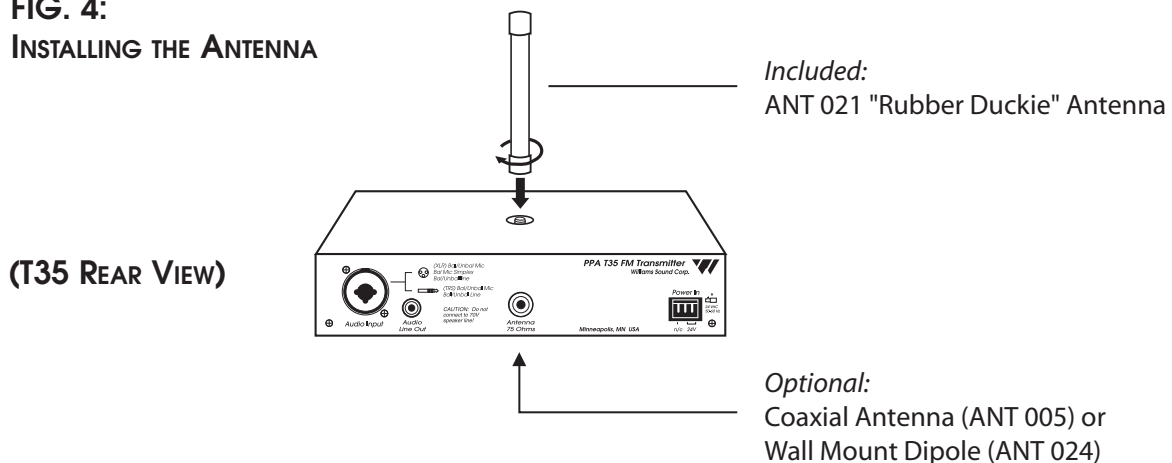

REMOTE ANTENNA TIPS:

Position the ANT 005 or ANT 024 antenna so the elements are *vertical*. The last 80 inches of the ANT 005 contain the elements. DO NOT install the antenna elements horizontally. The antenna should be placed as close to the listening area as possible (10 to 15 feet above the floor). DO NOT install the antenna directly above the listening area. There is a null in the coverage area off the ends of the antenna. DO NOT install the antenna around any significant amount of metal material; this may deflect and absorb the radio signal.

The ANT 005 and ANT 024 cables are classified as Class II wiring and may be installed in conduit with other Class II wiring. The antenna SHOULD NOT be installed with Class I (power) wiring. DO NOT connect the coaxial cable to the building or electrical ground in any way.

WIRING AND CONNECTIONS

FIG. 5: REAR VIEW OF T35

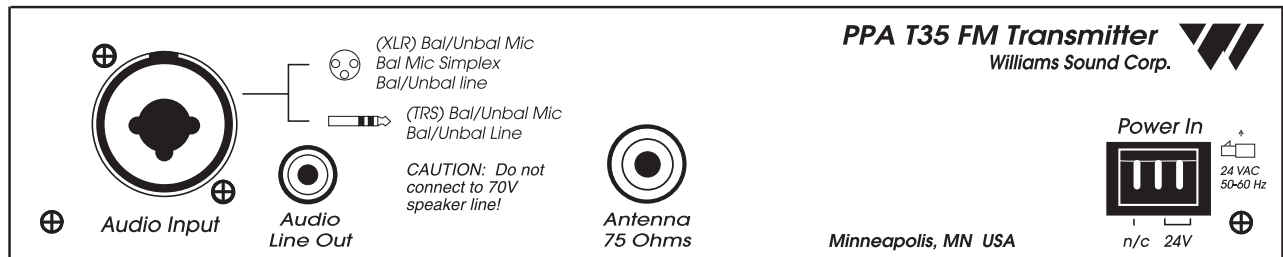

- ▶ **POWER SUPPLY CONNECTION FOR U.S. APPLICATION**
Connect the TFP 016 power supply to the "Power In" jack located on the rear of the T35 transmitter.

NOTE: The power on the T35 will not be activated until the power button on the front of the T35 is pressed into the "on" position.

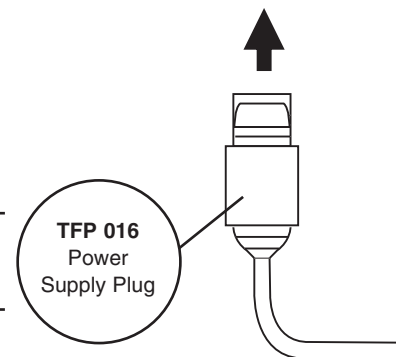

AUDIO SOURCE CONNECTIONS

The T35 transmitter will accept the following audio sources:

- 1) Balanced Microphone on a 3-pin (XLR) connector without simplex power.
- 2) Balanced Microphone with 12 volt simplex power (DIN 45596) on a 3-pin (XLR) connector.
- 3) Balanced/Unbalanced microphone without power on 1/4 inch jack
- 4) Balanced/Unbalanced Line on a 3-pin (XLR) connector.
- 5) Balanced/Unbalanced Line on 1/4 inch jack.

NOTE: The T35 is not designed to accept 70 volt speaker wire. The sound source should come directly from the system mixer or amplifier as an unprocessed signal.

IMPORTANT: When a suitable audio source has been selected, you MUST configure the *audio source controls* on the front panel of the T35. There are three possible selections to choose from: MIC, SIMPLEX-MIC and LINE. SEE PAGE 15 FOR AUDIO SOURCE CONTROLS. After the audio source selection has been made, plug in the appropriate audio source into the "Audio Input" jack in the rear of the T35.

FIGURE 6: AUDIO SOURCE CONNECTORS

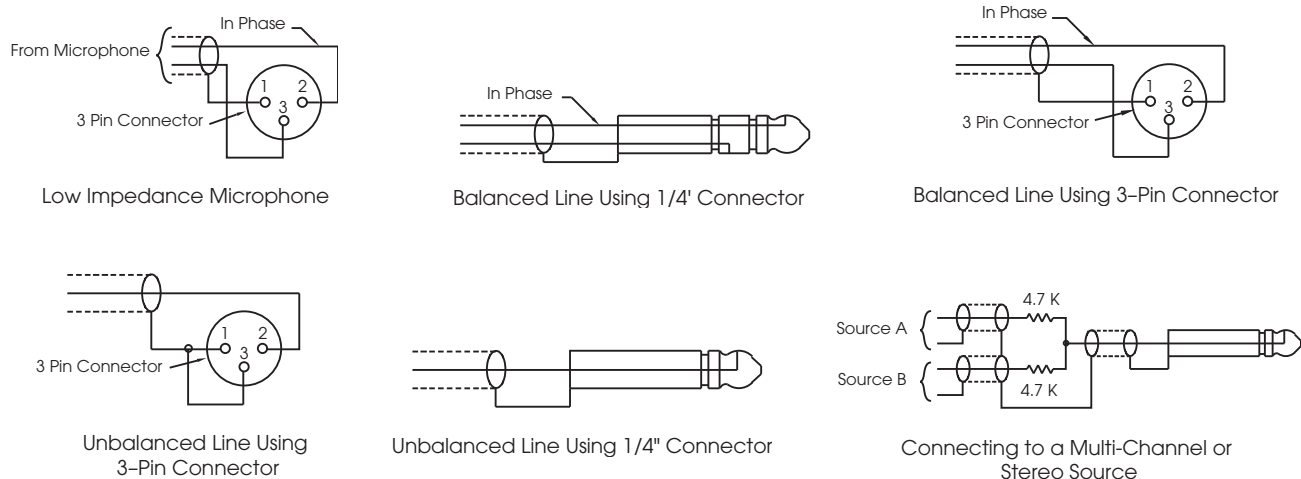

MULTI-CHANNEL SOURCES

By constructing a simple resistive mixer, stereo (or 3 channel) sources can be connected to the T35. Additional channels can be accommodated by adding a resistor for each source. Necessary resistors can be obtained from Williams Sound (Part Number RFC 472) or from any local electronics parts supplier. See Figure 6.

SELECTING AN AUDIO SOURCE APPROPRIATE FOR HEARING IMPAIRED LISTENERS

If the T35 is going to be used specifically for the accommodation of hearing impaired listeners, we recommend following these general guidelines:

The PPA T35 transmits audio with excellent fidelity. Therefore, the audio source signal should be of the highest audio quality and not subject to a compressor, limiter, reverb, or other signal processing equipment. The T35 has an effective audio processor. If compression is desired in the audio, refer to pages 16-17 for features and controls. Excessive compression is not helpful to the hearing impaired and can contribute to excessive noise in the receiver outputs.

The T35 audio source signal is usually connected to a mixer's "line output" signal which is behind the mixer's parametric equalizers but ahead of any equalization used for house loudspeakers.

If audio delay is available for use in large auditoriums, it's usually best to use it. Because radio signals travel faster than sound, delaying the transmitted audio so that an average listener (in the middle of the listening area) hears the transmitted audio a few milliseconds after audio from the main sound reinforcement system speaker is helpful. This will also help audience members who lip read.

AVOIDING HUM IN THE AUDIO (AS A RESULT OF A GROUND LOOP)

A hum created by a ground loop can often be eliminated by connecting a capacitor in series with the audio line shield to the transmitter's ground. This method also maintains good RF shielding. Determining the effectiveness of this method for your installation usually requires some experimentation. See Figure 7.

FIGURE 7: CONNECTING TO A BALANCE/UNBALANCED LINE

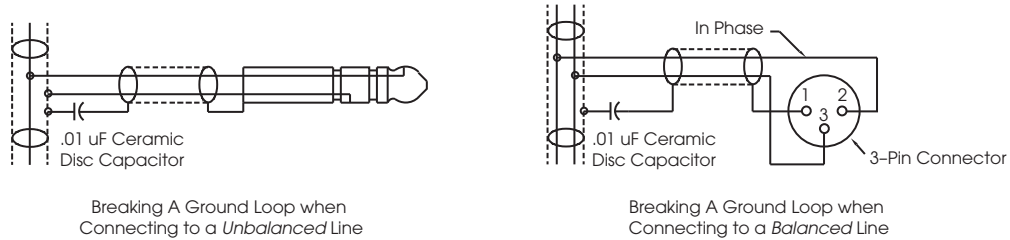

CONNECTING THE T35 TO A RECORDING DEVICE

Use the Audio Line Out jack for monitoring, recording, or routing processed audio to another sound system.

FIGURE 8: AUDIO LINE OUTPUT

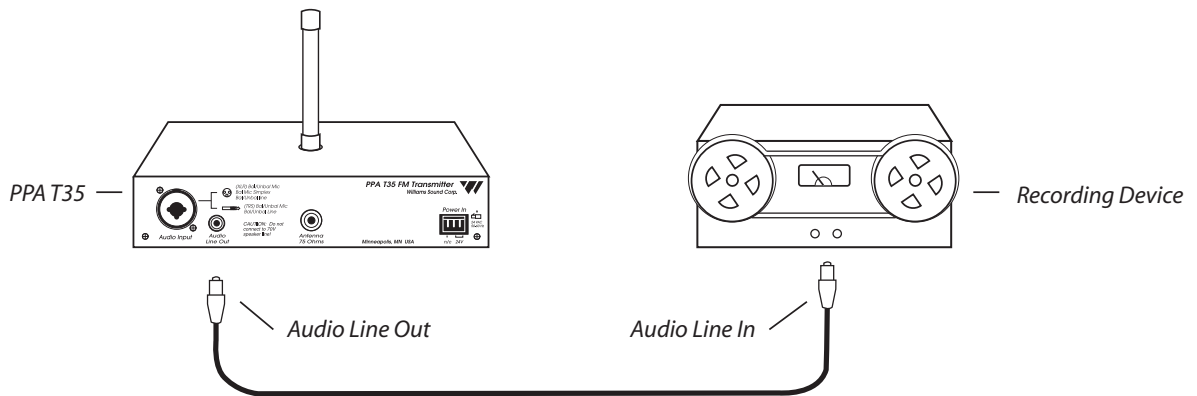

CONTROLS & FEATURES

FIGURE 9: PPA T35 FRONT VIEW

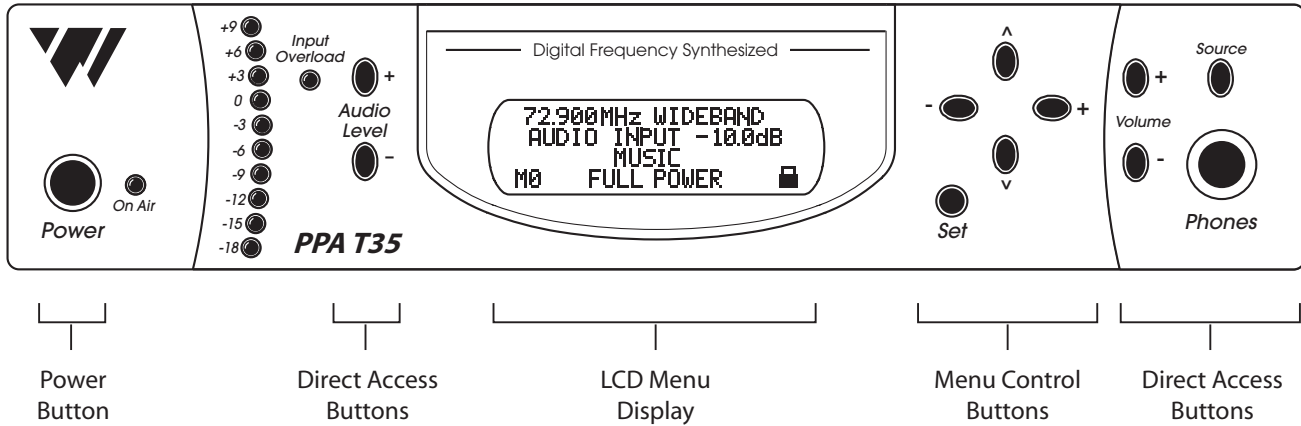

POWER BUTTON

Push-button switch turns the transmitter on or off. The wall mounted power supply stays on at all times.

ON AIR INDICATOR

Indicates when power is on and radio frequency is transmitting.

AUDIO LEVEL INDICATOR

The bar graph indicator shows audio level in 3dB steps at the input of the audio level processing circuit. The indicator is peak responding and is calibrated so that optimum level is reached when the 0dB LED generally lights and +9dB lights occasionally. Use the Audio Level controls to set the audio levels.

INPUT OVERLOAD INDICATOR

A red LED indicator will illuminate each time the audio signal exceeds the capacity of the input circuit. (The source of the audio coming in to the T35 needs to be adjusted to correct this.)

NOTE: Direct Access Buttons (Figure 9) allow the user to change configurations on the transmitter immediately without having to scroll through the menu controls (Page 12). When a direct access button is pressed, the change is immediately displayed on the LCD Menu Display.

AUDIO LEVEL (DIRECT ACCESS)

Pressing or holding down the Audio Level "+" button *increases* the audio input level in .5dB steps. Pressing or holding down the audio level "-" button *decreases* the audio input level in .5dB steps. Holding down an Audio Level button continuously will automatically increase or decrease the audio input in .5dB increments until the button is released or the upper and lower limits are reached. Each action is immediately displayed on the LCD default display (Figure 9).

PHONES JACK AND SOURCE BUTTON

A headset plugged into the "Phones" jack allows monitoring either the audio output as it is processed and transmitted by the T35 or the T35 audio input before it gets processed. By default, the phone jack audio is set for "TRANSMITTED" audio. Pressing and holding down the "Source" button will select "INPUT" audio. The setting is immediately displayed on the LCD menu screen. Releasing the "Source" button will immediately return the selection to "TRANSMITTED" audio. If there is no further action by the user, after five seconds, the LCD menu screen will return to the default display (Figure 10).

HEADPHONE VOLUME (DIRECT ACCESS)

The headphone level can be increased or decreased by using the "Volume" direct access buttons next to the headphone jack. Pressing or holding down the volume control "+" button increases the headphone level in +0.5dB steps. Pressing or holding down the volume control "-" button decreases the headphones level in -0.5dB steps. Holding down a Volume button continuously will automatically increase/decrease the input level in .5dB increments until the button is released or the limit is reached. Each action is immediately displayed on the LCD menu screen as the buttons are pressed. If there is no further action by the user, after five seconds, the LCD menu screen will return to the default display (Figure 10).

LCD MENU DISPLAY

The LCD display is used with the menu control buttons for configuring and setting up the T35. When the power of the unit is first turned on, the LCD screen displays a "Williams Sound" start-up screen. (NOTE: If the transmitter is not fully functional, the transmitter will stay on the start-up screen and the transmitter will not transmit.) After seven seconds, the "On Air" LED will illuminate and the default screen will be displayed (Figure 10). The T35 is now fully operational. If the "On Air" indicator does not illuminate, go back and double-check the connections (page 7). Make sure the power supply is properly installed, and the power button is in the "on" position.

FIGURE 10: Default Display Menu

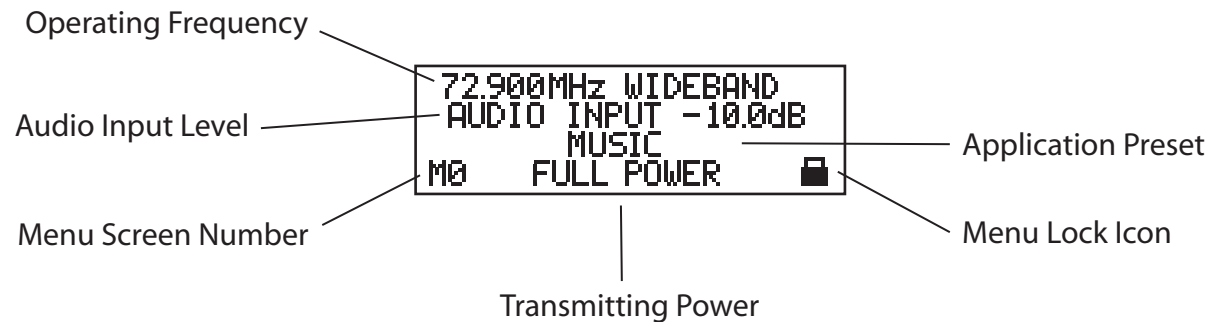

The default display will always show the following information: Operating Frequency, Bandwidth, Audio Input Level, Transmitting Power and Application Preset. In some cases the **Menu Lock Icon** will be displayed. This indicates that the menu screens (page 12) are locked, which prevents any functions from being accidentally changed (except for the *direct* access functions). To lock or unlock the menu screens, press and hold the SET button on the front of the T35 for five seconds. NOTE: This will only work from the *default* display.

LCD SCREEN MENUS (QUICK REFERENCE)

The first screen (M0) gives important overall system settings. The following nine menu screens (M1-M9) are used to configure and setup the T35. To make a screen selection, navigate to the desired LCD menu by pressing the "v" (down) button on the front of the T35. Press the "Set" button to save the change into memory. *Any changes not "set" will be lost.* After 30 seconds of inactivity, the LCD will return to the default display.

FIGURE 11: SELECTING AN LCD MENU

LED Menu Controls

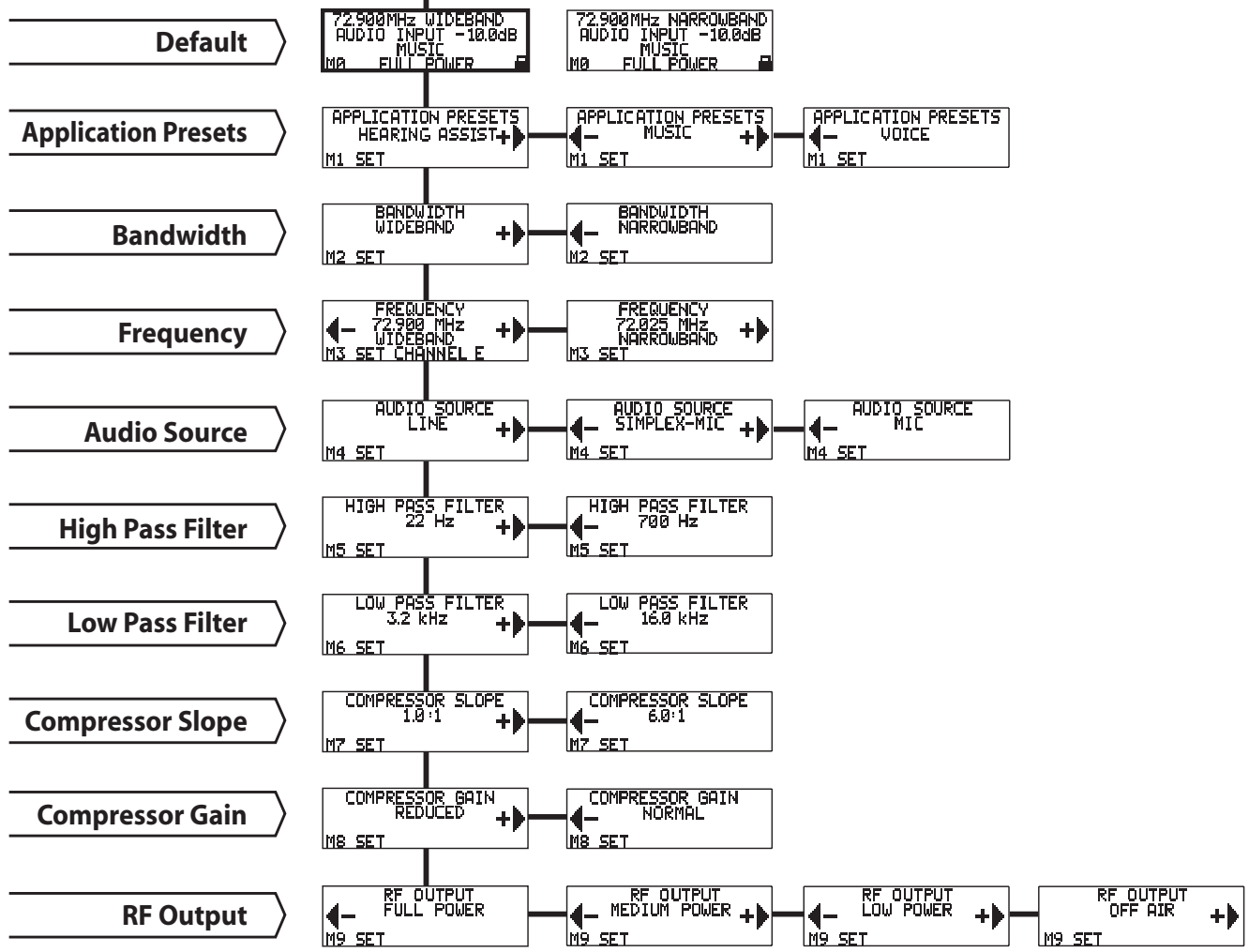
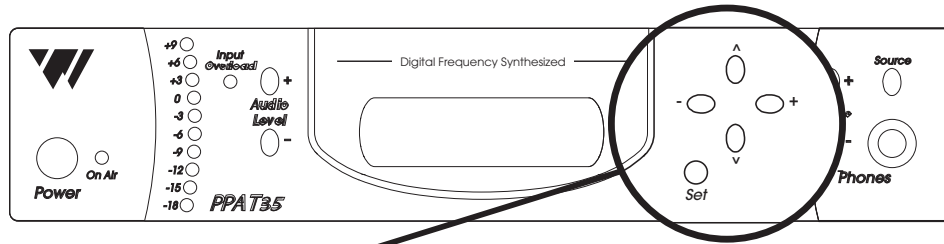

LCD SCREEN MENUS (DETAILED)

APPLICATION PRESETS (M1)

The Application Presets screen allows the user to quickly and easily configure the T35 for common applications. In some cases, the Application Presets will be the only setup needed for properly configuring the T35 transmitter.

There are three Application Presets to choose from: **Hearing Assist**, **Music** and **Voice**. When one of these selections is "set," the performance of the T35 is immediately optimized for the needs of that application (an adjustment is automatically made to the Low/High Pass Filter, and Compressor Slope controls). Refer to the chart below for a comparison of the Application Preset configurations.

By default, the T35 is shipped in the **Music** mode. For music, concerts, and other applications where the highest audio quality is desirable, **Music** is the recommended mode of operation. For *hearing assistance* applications, or applications where the message is critical for listening, **Hearing Assist** is the recommended mode of operation. For speaking and other *voice* applications, **Voice** is the preferred mode of operation.

To select an Application Preset:

FIGURE 12:
LCD Menu Controls

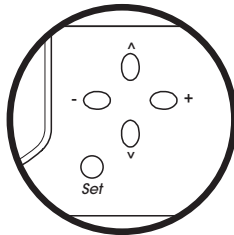

Front panel of the T35

- 1) Press the "v" menu button (Figure 12) to access the LCD "Application Presets" screen (M1).
- 2) Press the "+" or "-" menu buttons to select between Hearing Assist, Music and Voice.
- 3) When the desired Application Preset is displayed, press the "Set" button to save the change into memory.

No additional action is necessary. After 30 seconds of inactivity, the LCD screen will return to the default screen, where the selected Application Preset will be displayed. NOTE: After an Application Preset has been selected, any of the configurations can manually be changed if necessary.

Application Preset Configuration Table

RF Output = Full Power, Compressor Gain = Normal

Parameters:	Wide Band			Narrow Band		
	Hearing Assist	Music	Voice	Hearing Assist	Music	Voice
Low Pass Filter	8.0 kHz	16 kHz	6.3 kHz	6.3 kHz	6.3 kHz	6.3 kHz
High Pass Filter	500 Hz	22 Hz	125 Hz	500 Hz	22 Hz	125 Hz
Compressor Slope	2.0: 1	1.0:1	1.0:1	2.0:1	1.0:1	1.5:1

The Application Presets are designed to take the guess work out of common setup procedures. There will be times when manual adjustments will need to be made (i.e. to select a different operating frequency, bandwidth, to adjust the compression ratio, etc.). For these requirements, please read through the manual and follow the corresponding menu control instructions. If you are unsure of how these changes will impact the performance of the T35 transmitter, or how it will affect your hearing assistance application, please contact Williams Sound for assistance at 800-843-3544.

BANDWIDTH (M2)

The default LCD menu screen (as shown on page 11, Figure 10) will always display the user selected bandwidth as "Wideband" or "Narrowband." The T35 is shipped from the factory in Wideband mode. First determine the bandwidth of the associated receiver, then set the T35 to that bandwidth:

- 1) Press the "v" menu button (Figure 12) to access the LCD "Bandwidth" (M2) screen.
- 2) Press the "+" or "-" menu buttons to select between Narrowband and Wideband.
- 3) When the desired bandwidth is displayed, press the "Set" button to save the change into memory.

No additional action is necessary. After 30 seconds of inactivity, the LCD screen will return to the default screen, where the selected bandwidth will be displayed.

FREQUENCY (M3)

First determine the bandwidth and frequency of the associated receiver, then set the T35 to that bandwidth (see above) and frequency:

Available Frequencies:

- ① If the wideband operation is selected, 10 wideband frequencies and 7 non-standard wideband frequencies are available. *Standard Frequencies:*
72.100 (CH A), 72.300 (CH B), 72.500 (CH C), 72.700 (CH D), 72.900 (CH E), 74.700 (CH I), 75.300 (CH J), 75.500 (CH F), 75.700 (CH G) and 75.900 MHz (CH H).

Non-standard Frequencies:

72.2 (CH K), 72.4 (CH N), 72.6 (CH O), 72.8 (CH P), 75.4 (CH R), 75.6 (CH S), 75.8 (CH T).

- ② If the narrowband operation is selected, seventy-seven narrowband frequencies are available:
72.025, 72.050, 72.075, 72.100, 72.125, 72.150, 72.175, 72.200, 72.225, 72.250, 72.275, 72.300, 72.325, 72.350, 72.375, 72.400, 72.425, 72.450, 72.475, 72.500, 72.525, 72.550, 72.575, 72.600, 72.625, 72.650, 72.675, 72.700, 72.725, 72.750, 72.775, 72.800, 72.825, 72.850, 72.875, 72.900, 72.925, 72.950, 72.975, 74.625, 74.650, 74.675, 74.700, 74.725, 74.750, 74.775, 75.225, 75.250, 75.275, 75.300, 75.325, 75.350, 75.375, 75.400, 75.425, 75.450, 75.475, 75.500, 75.525, 75.550, 75.575, 75.600, 75.625, 75.650, 75.675, 75.700, 75.725, 75.750, 75.775, 75.800, 75.825, 75.850, 75.875, 75.900, 75.925, 75.950, and 75.975 MHz.

The T35 is shipped from the factory with the frequency pre-set to 72.900 MHz. *To change the frequency:*

- 1) Press the "v" menu button to select the LCD "Frequency" (M3) screen.
- 2) To increase the frequency, press the "+" menu button.
To decrease the frequency, press the "-" menu button.

Holding down the "+" or "-" menu buttons will change the frequency automatically until the highest or lowest available frequency has been met.

- 3) When the desired frequency is displayed, press the "Set" button to save the change into memory.

No additional action is necessary. A new adjustment may now be made, or after 30 seconds of inactivity, the LCD screen will return to the default screen, where the selected frequency will be displayed.

NOTE: The T35 will not broadcast on the newly selected frequency until the "set" button has been pressed.

REMINDER: If the lock icon  is displayed on the default display, the menu screens are locked, and you will not be able to make changes. To unlock the menu screens, refer to the instructions on page 11.

AUDIO SOURCE (M4)

The Audio Source control menu is used to configure the T35 for a proper audio source connection. The transmitter will accept the following audio sources:

- 1) **Balanced Microphone on a 3-pin (XLR) connector without simplex power.**
- 2) **Balanced Microphone with 12 volt simplex power (DIN 45596) on a 3-pin (XLR) connector.**
- 3) **Balanced/Unbalanced microphone without power on 1/4 inch jack**
- 4) **Balanced/Unbalanced Line on a 3-pin (XLR) connector.**
- 5) **Balanced/Unbalanced Line on 1/4 inch jack.**

The Audio Source menu has three possible selections to choose from: MIC, SIMPLEX-MIC, or LINE. To select the audio input:

- 1) Press the "v" menu button (Figure 12) to access the LCD "Audio Source" (M4) screen.
- 2) Press the "+" or "-" menu buttons to select between MIC, SIMPLEX-MIC, or LINE.
- 3) When the desired audio input is displayed, press the "Set" button to save the change into memory.

No additional action is necessary. After 30 seconds of inactivity, the LCD screen will return to the default display.

HIGH PASS FILTER (M5)

The high pass filter will help to remove low frequency "noise" from the transmitted audio signal. This is typically used when there is room noise, a line hum, or breath accents picked up from an improperly installed microphone.

To select a High Pass Filter cutoff frequency:

- 1) Press the down "v" menu button (Figure 12) to select the LCD "High Pass Filter" (M5) screen.
- 2) Press the "+" menu button to increase the cutoff frequency.
Each time the "+" button is pressed, the cutoff frequency will be raised by 1/2 octave. This can be repeated until the cutoff frequency reaches the maximum 700 Hz.

Press the "-" menu button to decrease the cutoff frequency.
Each time the "-" button is pressed, the cutoff frequency will be lowered by 1/2 octave. This can be repeated until the cutoff frequency reaches the minimum 22 Hz.
- 3) When the desired cutoff frequency is displayed, press the "Set" button to save the change into memory.

No additional action is necessary. After 30 seconds of inactivity, the LCD screen will return to the default display.



IMPORTANT: Listen to the transmitted audio through the headphone jack, especially when deciding on an appropriate high pass filter. This is a good way to ensure the listening audience is going to receive the highest audio quality.

LOW PASS FILTER (M6)

The low pass filter will help to remove high frequency "noise" from the transmitted audio signal. This is typically used when there is a hiss in the audio line as a result of room noise, speech sibilants, or other high frequency unpleasanties.

To select a Low Pass Filter cutoff frequency:

- 1) Press the down "v" menu button (Figure 12) to select the LCD "Low Pass Filter" (M6) screen.
- 2) Press the "+" menu button to increase the cutoff frequency selection.
The cutoff frequency can be increased to a maximum of 16.0 kHz.

Press the "-" menu button to decrease the cutoff frequency selection.
The cutoff frequency can be decreased to a minimum of 3.2 kHz.
- 3) When the desired cutoff frequency is displayed, press the "Set" button to save the change into memory.

No additional action is necessary. After 30 seconds of inactivity, the LCD screen will return to the default display.



IMPORTANT: Listen to the transmitted audio through the headphone jack, especially when deciding on an appropriate low pass filter. This is a good way to ensure the listening audience is going to receive the highest audio quality.

COMPRESSOR SLOPE (M7)

Compression is typically used for voice and hearing assistance applications. It reduces the dynamic range: For a listener who has difficulty hearing the quiet sounds of an audio broadcast, compression will boost the quiet sounds to louder listening levels. For listening to music programs, concerts, etc., lower compression ratios or no compression is generally used.

The Compressor Slope has the following selectable compression ratios:

1.0:1, 1.1:1, 1.2:1, 1.3:1, 1.4:1, 1.5:1, 1.6:1, 1.8:1, 2.0:1, 2.2:1, 2.5:1, 3.0:1, 3.5:1, 4.0:1, 4.5:1, 5.0:1, 5.5:1, 6.0:1.

NOTE: The T35 is shipped from the factory at a 1.0:1 compression ratio (no compression).

To select a compression ratio:

- 1) Press the "v" menu button (Figure 12) to select the LCD "Compressor Slope" (M7) screen.
- 2) Press the "+" menu button to increase the steps of compression. The compression ratio can increase to a maximum of 6:1, which produces generally loud output, even at very low audio level signals.

Press the left "-" menu button to decrease the steps of compression. The compression can be lowered to a minimum ratio of 1.0:1, which is no compression.
- 3) When the desired compression ratio is displayed, press the "Set" button to save the change into memory. No additional action is necessary.

NOTE: The installer of the T35 needs to take care in using compression, because some hearing impaired people cannot tolerate as loud of a sound as those with normal hearing.

FIGURE 13: AUDIO PERFORMANCE USING COMPRESSION

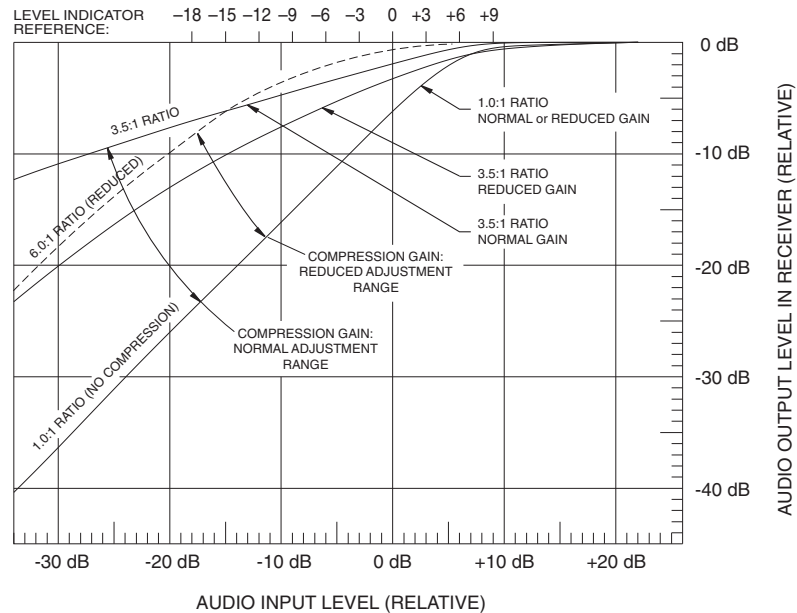

COMPRESSOR GAIN (M8)

The T35 has two selectable modes of compression: Normal and Reduced. For applications such as music and voice, where the highest audio quality is desirable, *Reduced* compression is the recommended mode of operation. Reduced compression minimizes the amount of boost and disturbances in the sound which compression can cause.

For hearing assistance or applications where the transmitting message is critical for listening, the T35 can be set to Normal Compression gain. Normal compression boosts the “soft” audio sounds for a more understandable, consistent delivery. This may be appropriate for applications where the listening audience has moderate to severe hearing loss. Additional compression can be added (if desirable) by adjusting the Compressor Slope control. See page 16. Normal compression gain is generally not desirable for applications such as music, concerts, etc.

NOTE: The T35 is shipped from the factory in the *Reduced mode*.

To select *Reduced* or *Normal* Compression:

- 1) Press the “v” menu button (Figure 12) to access the LCD “Compressor Gain” (M8) screen.
- 2) Press the “+” or “-” menu buttons to select between *Reduced* and *Normal* compressor gain.
- 3) When the desired compressor gain is displayed, press the “Set” button to save the change into memory.

No additional action is necessary. After 30 seconds of inactivity, the LCD screen will return to the default display.

NOTE: The installer must take care in using compression. Adding too much compression may contribute to excessive noise in the listener’s receivers.



IMPORTANT: Listen to the transmitted audio through the headphone jack, especially when deciding on an appropriate compressor gain and slope. This is a good way to ensure the listening audience is going to receive the highest audio quality.

RF OUTPUT (M9)

The T35 has three selectable transmitter power levels: FULL, MEDIUM, LOW POWER, or OFF AIR. By default the T35 is set to "Full" power mode. For general listening applications, FULL power is the preferred mode of operation. "Full power" provides the T35 with an operating range of up to 500 ft. For special listening applications, it may be desirable to reduce the overall operating range on the T35 if: 1) The audio transmission is to be contained to a "smaller" listening area; 2) The signal is too strong and it is overloading the receiver; or 3) Multiple T35 transmitters are used in adjacent classrooms where the FM signals overlap each other. In these cases, the power level on the T35 can be reduced to MEDIUM or LOW. The RF output may be set to OFF AIR (no power) to help troubleshoot interfering or overlapping RF signals.

To select a power level:

- 1) Press the "v" menu button (Figure 12) to access the "RF Output" (M9) screen.
- 2) Press the "+" and "-" menu button to select between: FULL POWER, MEDIUM POWER, LOW POWER and OFF AIR.
- 3) When the desired power level is displayed, press the "Set" button to save the change into memory.

No additional action is necessary. After 30 seconds of inactivity, the LCD screen will return to the default display, where the selected power level will be displayed.

WIDEBAND FM RECEIVERS (OPTIONAL)

RECEIVER MODEL PPA R30

The R30 is a single-channel wideband receiver pre-tuned to 72.9 MHz (additional wideband frequencies are available from 72 MHz-76 MHz). It features a single volume control on/off switch, LED on indicator, and earphone jack. *Instructions:*

FIG. 14

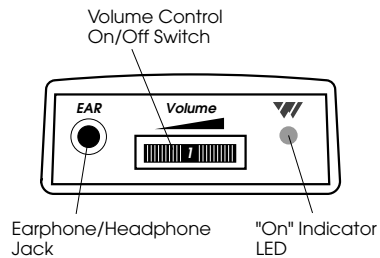

R30 Top

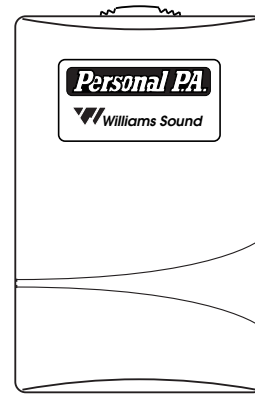

R30 Front

BATTERY INSTALLATION

Open the battery compartment using a coin in the slot in the bottom of the receiver. Press the AA batteries into place (see "Receiver Battery Information" on page 24), **observing proper battery polarity**. Incorrect insertion of the batteries is difficult, and may cause both mechanical and electrical damage to the receiver not covered by the 5 year warranty. The receiver will not work with the batteries incorrectly installed.

CONNECTING EARPHONES

Plug an earphone into the jack near the thumb wheel volume control. Only monophonic earphones will operate properly. If stereo headphones are used, sound will be heard only in one side. A suitable adapter (Radio Shack Part #274-368) can be used so that stereo earphones operate on both sides. Williams Sound extensively evaluates the earphones and headphones included with the PPA R30. We can only assure optimum performance when Williams Sound earphones and headphones are used.

OPERATING THE RECEIVER

NOTE: If you're using the PPA T35 transmitter, make sure the transmitter is on and receiving a good audio input. Also, make sure the T35 is operating in Wideband mode, and transmitting on the same frequency as the receiver.

Turn the receiver on by rotating the volume control dial in the direction of the arrow on top of the case. The "On" indicator will illuminate.

Turning the dial in the direction of the arrow will increase the volume. Turning the dial against the arrow will decrease the volume. To avoid depleting the batteries, make sure the receiver is turned off when not in use.

If you're using the PPA T35 with a microphone—and not a complete sound system—have someone speak into the microphone while you listen with the receiver and earphone. You should be able to hear their voice through the receiver.

Note: The earphone cord is the receiving antenna. Do not bunch up the cord or wrap it around the receiver while in use.

ADDITIONAL WIDEBAND RECEIVER OPTIONS

MODEL PPA R7-4

The R7-4 is a four-channel wide-band receiver, pre-tuned to frequencies 72.1, 72.5, 72.9, and 75.7 MHz*. It features a channel select knob, volume control on/off switch, and an earphone/charging jack. To operate, simply turn the select knob to the desired frequency, and adjust the volume control to a comfortable listening level.

FIG. 15

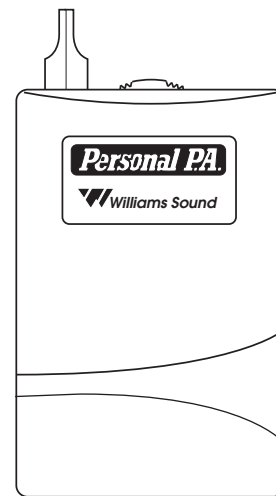
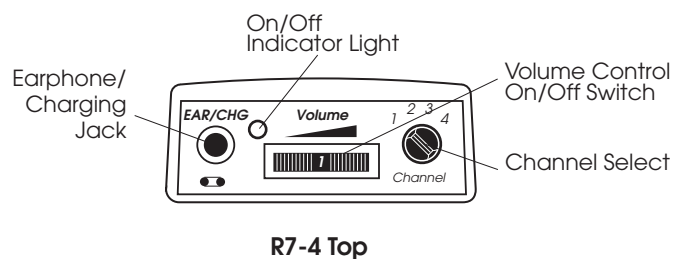

*Additional channels are available from 72 - 76 MHz.

RECEIVER (WIDEBAND) FREQUENCY CHANGE INSTRUCTIONS

Selecting a frequency for the R30, R31, R32 and R7-4 receivers requires an adjustment to the internal tuning coil(s). See Figure 16 for receiver types to locate the coils to be adjusted. A plastic tuning wrench (PLT 005) will be needed to adjust these receiver tuning coils.

FIG. 16

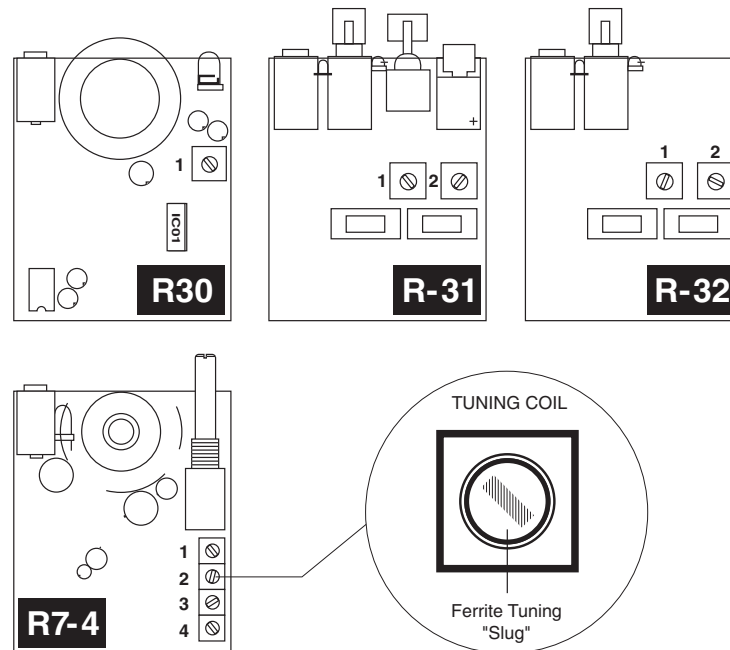

Most Williams Sound single channel Receivers are set at the factory to 72.9 MHz. The standard four-channel receivers (R7-4), channels 1-4, are usually set to frequencies 72.1, 72.5, 72.9, 75.7 MHz respectively.

The Receiver must be tuned with a weak and somewhat noisy signal. If tuned too close to the transmitter, with a strong signal, the most accurate tuning of the receiver is not possible.

To Change the Frequency to Another Channel:

- Step 1:** Set the transmitter to the channel desired and remove the antenna.
- Step 2:** Connect an audio source to the transmitter such as a CD or cassette player or microphone.
- Step 3:** Move the receiver about 25 feet away from the transmitter to set the tuning.
- Step 4:** Open the battery compartment, then pull the battery door to the left like a book to open the back of the receiver.
- Step 5:** Locate the Tuning Coil (see Figure 16). Each tuning coil is a small, square, shiny metal can with a screwdriver slot in a tuning slug in the top center. The Tuning Slug is usually black or gray.

- Step 6:** With the earphone or headphone supplied with the receiver plugged into the Ear Jack, turn the volume control to a comfortable level, and listen for the transmitted signal.
- Step 7:** Gently put the tip of the tuning tool into the slot in the tuning slug. Be careful not to push hard on the slug so as not to damage the threads in the coil, and do not screw it down more than 3 turns into the coil.
- Step 8:** Turn the tuning slug in a counter-clockwise direction about two turns. Then, slowly turn the tuning slug in the clockwise direction until the signal is heard. There may be two signal points heard. The one which is received first is a false response. Be sure to continue tuning slightly further to the correct point, which will be much louder. Tune back and forth to find the center of the point of best response to the audio source being heard.
- Step 9:** Mark down the date, and if a new frequency has been chosen, mark it down inside the receiver case for future reference.

NARROWBAND FM RECEIVERS (OPTIONAL)

RECEIVER MODEL PPA R19

The R19 is a two-channel narrowband receiver operating on 72.900 and 75.700 MHz frequencies. It features volume control on/off switch, channel selection switch, earphone jack, tone control selection switch and on/off power indicator.

NOTE: The R19 and R19-6 narrowband receivers use crystals to designate frequency selection and are therefore not field tunable. To select a different operating frequency, the receiver must be returned to Williams Sound for service.

FIG. 17

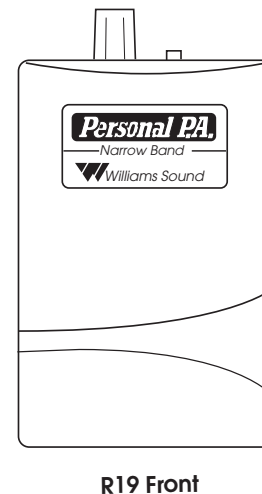
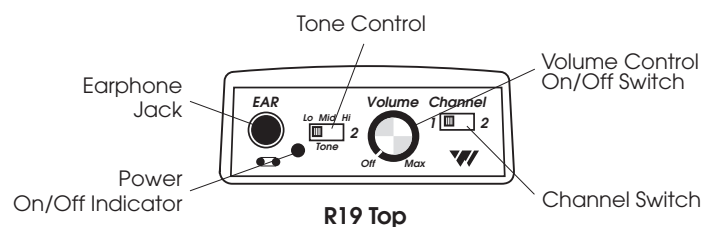

Instructions:

BATTERY INSTALLATION

Open the battery compartment using a coin in the slot in the bottom of the receiver. Observing proper polarity, press the AA batteries into place (see "Receiver Battery Information" on page 24). **NOTE:** Incorrectly installed batteries may cause damage to your receiver, which will void the five year warranty.

CONNECTING EARPHONES

Plug an earphone into the "Ear" jack on the top of the R19 receiver. Only monophonic earphones will operate properly. If stereo headphones are used, sound will be heard only in one side. A suitable adapter (Radio Shack Part #274-368) can be used so that stereo earphones operate on both sides.

OPERATING THE RECEIVER

NOTE: If you're using the PPA T35 transmitter, make sure the transmitter is on and receiving a good audio source. Also, make sure the T35 is operating in Narrowband mode, and transmitting on the same frequency as the receiver (72.900 MHz or 75.700 MHz).

Turn the receiver on by rotating the volume control knob clockwise. A green power LED indicator will illuminate. If the power indicator does not illuminate, go back and make sure the batteries are properly installed. If you are using rechargeable batteries, you may need to charge the batteries overnight before operating the receiver.

Choose an operating frequency by sliding the channel selection switch to position 1 (72.900 MHz) or position 2 (75.700 MHz).

Turn the volume control knob clockwise until the audio is at a comfortable listening level. Adjust the tone controls as needed by sliding the tone selection switch to low, mid, or high. When you're done using the receiver, be sure to turn off the unit. This will help extend the life of the batteries.

ADDITIONAL NARROWBAND RECEIVER OPTIONS

MODEL PPA R19-6

The R19-6 is a six-channel narrowband receiver, pre-tuned to channels 72.1, 72.5, 72.9, 74.7, 75.3, and 75.7 MHz. It features a six-channel select knob, volume control on/off switch, earphone jack, and power LED indicator. To operate, simply turn the volume control knob clockwise to turn the unit on. The power LED indicator should illuminate. Turn the channel switch to the desired frequency, and adjust the volume control knob to a comfortable listening level.

FIG. 18

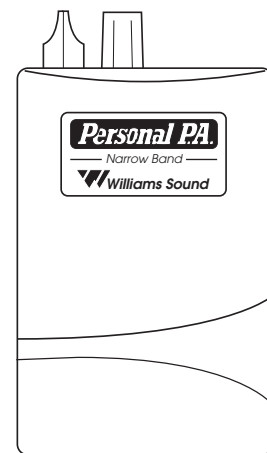
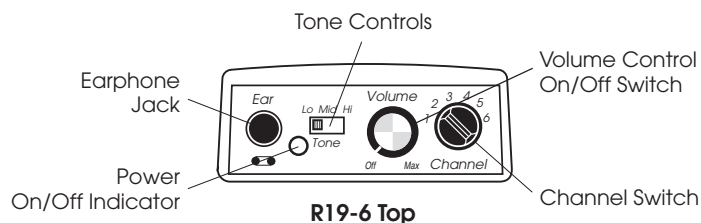

R19-6 Front

SUGGESTIONS FOR RECEIVER MANAGEMENT

Different types of facilities use varying approaches to receiver management and earphone sanitation. Below are some options that customers have used successfully.

1. *Regular users purchase or are given their own receiver and take care of their own batteries and earphones.*
2. *The facility labels a receiver and earphone for each regular user. The facility maintains the units.*
3. *Ushers issue receivers to people who request them.*

Earphones are sanitized after use. Foam ear cushions can be replaced or washed with a mild detergent, rinsed thoroughly and air-dried. The EAR 022 Surround Earphone can be sanitized with an alcohol pad.

The receivers can be stored in a multiple compartment storage case with a credit card or driver's license left as collateral for the receiver.

4. *Regular users purchase their own earphone or headphone and bring them to use with receivers at the facility.*

RECEIVER BATTERY INFORMATION (ALL RECEIVER MODELS)

DISPOSABLE BATTERIES

In normal use, two AA 1.5 V non-rechargeable Alkaline batteries will last about 80 hours (for 9V battery information, refer to page 29). If the sound becomes weak or distorted, replace the battery. The indicator light may still be on, even with a battery that is weak. Do not leave dead batteries in the receivers. Battery corrosion is not covered by the Williams Sound five year warranty.

RECHARGEABLE BATTERIES

The R30 and R19 can also use two AA 1.5 V Ni-Cad or NiMH rechargeable batteries (BAT 026). Two fully charged BAT 026's will provide up to 50 hours of use. Damage from improper charging is not covered by the Williams Sound five year warranty.

The batteries installed in the receiver may be recharged in the receiver **only if they are Nickel Metal Hydride or NiCad batteries, and only if the correct Williams Sound charger is used.**

Recharge batteries only with a Williams Sound CHG 200A 3V Dual Charger or the CHG 1600 Multiple Battery Charger. Make sure the receiver is turned off during charging. A complete recharge cycle takes about 14 hours. Receivers should not be left charging continuously when not in use.

!! IMPORTANT WARNINGS !!

DO NOT ATTEMPT TO RECHARGE ZINC CARBON ("HEAVY DUTY"), ALKALINE, OR LITHIUM BATTERIES!

DO NOT ATTEMPT TO RECHARGE DISPOSABLE BATTERIES! These batteries may heat up and explode, causing possible injury and damage to the equipment.

Avoid shorting the plus and minus battery terminals together with metal objects. Battery damage and burns can result!

Use only Williams Sound supplied chargers and rechargeable batteries!

TROUBLE SHOOTING

THE T35 “ON AIR” INDICATOR IS NOT ON

- ▶ Make sure the transformer (TFP 016) is plugged into the transmitter and any remote power switch is on.
- ▶ Make sure the electrical outlet is on.
- ▶ Make sure the power button on the front of the T35 is pressed to the “on” position.
- ▶ Make sure the 24 VAC power supply is working.
- ▶ Make sure the RF output is not set to “OFF AIR.”

NO AUDIO HEARD IN PHONES JACK

- ▶ Check to see if there is a signal coming from your audio source. Check and correct your audio source if necessary.
- ▶ Check to see if the Headphone Volume Level has been turned all the way down. If so, increase it.
- ▶ Check to see if there is an incorrect or defective connection from your audio source. See page 7 for detailed connection instructions.

NOISE OR DISTORTION IN THE AUDIO

- ▶ Check to see if there is noise in the audio source. To find out, disconnect the audio cable. If the noise disappears your noise problem is in the source. Correct or repair your audio source.
- ▶ Perhaps the Audio Source control is not set to match your audio source input device. See page 15 to properly configure the Audio Source control menu.
- ▶ Check to see if the Audio Input level is set too high. If the “input overload” is illuminated, then the audio level needs to be adjusted. See page 10.
- ▶ Check for ground loops or noise on the input signal. See page 9 for more information. Call your Authorized Williams Sound dealer or representative.

NOISE IN AUDIO “GROWS” WHEN PROGRAM IS SILENT

- ▶ The Audio Level Control may be set too high. You’re probably also seeing the +6 level indicator lighting all the time. To correct, adjust the Audio Level control on the front of the T35. See page 10.
- ▶ It could be that the T35 Audio Processor is set for Normal Compression, which may be inappropriate for the type of program being transmitted. Reset the Compressor Gain control to Reduced. See page 17.
- ▶ It could be that the T35 Compressor Slope ratio is set too high, which may be inappropriate for the type of program being transmitted. Reset the Compression Slope control to 1.0:1. See page 16.

RECEPTION (AT RECEIVER) DIFFICULTIES

NOTE: Be sure to listen to the audio transmission on the T35 phone jack prior to checking the receiver reception.

NO RECEPTION

- ▶ Check to see if the antenna on the T35 has been disconnected. If so, attach the antenna correctly.
- ▶ Check to see if the RF output power on the T35 is set to “OFF.” If so, reset the RF Output control to FULL, MEDIUM or LOW power. See page 18.

- ▶ Make sure the FM receiver is ON. Make sure the batteries are properly installed (observing proper polarity). If the batteries are rechargeable, it may be necessary to charge the batteries overnight.
- ▶ Make sure the FM receiver is operating on the same frequency as the T35. Make sure the receiver is operating on the same bandwidth as the T35: Wideband or Narrowband. Follow tuning instruction for the receiver and adjust accordingly.

INSUFFICIENT RANGE, GOOD RECEPTION NEAR TRANSMITTER, POOR AT A DISTANCE

- ▶ Check to see if the transmitting antenna was installed incorrectly. If so, correct or replace the antenna. The signal should be clearly audible at a 300 foot distance with the ANT 021 and a 500 foot distance with the ANT 005.
- ▶ Make sure the transmitting antenna is not in an unsuitable location. Perhaps the transmitting antenna was installed inside a metal enclosure or is separated from the reception area by electrically conducting objects. (i.e., steel stud walls, heating ducts, substantial structural steel, or 2x2 or 2x4 ceiling grid.) In either case, reinstall the antenna according to installation instructions, locating it outside metal enclosures and away from electrically conducting objects.
- ▶ Perhaps there is a strong interfering signal. If so, make sure the transmitter and antenna are correctly installed. Set the transmitter to FULL power output. If this does not solve the problem, try operating the transmitter on a different frequency. If operating the T35 in wideband mode, try switching to narrow band operation (see page 14). Narrowband operation is more resistant to outside interference.

USERS MUST TURN RECEIVER VOLUME CONTROLS WAY UP (TO 4 OR 5) TO GET ENOUGH VOLUME

- ▶ Perhaps there is insufficient audio level. If so, the audio level indicator will read too low because the audio level control is set incorrectly on the transmitter. Correct the Audio Level control setting. See page 10.
- ▶ It could be that the audio input is not configured for the audio source being used. If not, correct the setting of the Audio Source control menu. See page 15.
- ▶ Some users may not be helped by this system. Severe hearing loss may require using the system with a telecoil coupler (i.e., Neckloop) and personal hearing aid.
- ▶ Check your batteries. For non-rechargeable (alkaline) batteries, they may need replaced. If you are using rechargeable batteries, make sure the batteries are fully charged prior to use.

USERS COMPLAIN OF TOO MUCH NOISE DURING SOFT AUDIO. DYNAMIC RANGE OF MUSIC REDUCED TOO GREATLY.

- ▶ Check to see if the Audio Level control is set too high. This problem is more likely to occur in Normal Compression mode, but can also occur in Reduced Compression mode. To reduce this noise, adjust the Audio Level, carefully noting the Level Indicator. The +6 LED should light occasionally.
- ▶ Perhaps the transmitter is set for Normal Compression when Reduced Compression would be more suitable, given the program material. If so, set the Compressor Gain control to Reduced Compression. See page 17.

BUZZ IN OTHER EQUIPMENT WHEN TRANSMITTER IS ON OR OFF

- ▶ This is not an RF problem. Instead, it is likely caused by incorrect audio connections, a ground loop, or defective equipment. To remedy, use proper audio wiring practice to make connections described on page 8.

BUZZ OR OTHER NOISE IN EQUIPMENT ONLY WHEN TRANSMITTER IS ON

- ▶ This is likely an RF-induced disturbance in the other equipment. To remedy, try these steps in order until the buzz is eliminated:

1. Make certain the transmitter chassis is connected to the equipment cabinet rails. Buzz/hum in system may be experienced when the T35 chassis is insufficiently grounded. In this case, install a ground wire to the T35 chassis and terminate to a known good ground source.
2. Make sure antenna connections are secure.
3. Set the T35 Transmitter to MEDIUM power output on the RF Power menu choice.
4. Install transmitter at a distance from sensitive equipment.
5. Use a remote antenna (ANT 005 or ANT 024).
6. Make sensitive equipment more immune to RFI/EMI. The manufacturers of your audio equipment may offer application notes for this purpose. Williams Sound offers a document giving suggestions for improving RF immunity in existing audio equipment (*Technical Bulletin: Buzz Or Hum In The Sound System, FRM 531*).

WARRANTY

The Williams Sound T35 Transmitter is engineered and designed to provide you with many years of reliable service. Williams Sound warrants it against defects in materials and workmanship for FIVE (5) years EXCEPT FOR earphones, headphones, rechargeable batteries, chargers, cables, antennas, carry cases, and all other accessory products. Accessory products carry a 90 day warranty.

If this product fails within the specified warranty period, Williams Sound will determine whether to repair or replace the defective equipment. This warranty does not apply to physical damage, abuse, mis-use, or products that have been modified.

*If you experience difficulty with your system, call for Customer Assistance:
1-800-843-3544.*

If it is necessary to return the system for service, a Williams Sound representative will give you a Return Authorization Number (RA) and shipping instructions. Pack the system carefully and send it to:

Williams Sound Corp.
10321 West 70th Street
Eden Prairie, MN 55344-3459 USA

Phone: 800-843-3544 / 952-943-2252
Fax: 952-943-2174
TTY: 952-943-9675
e-mail: info@williamssound.com

Your warranty becomes effective the date you purchase your system. Your returned warranty card is our way of knowing when your warranty begins. You may also choose to register your product online:

<http://www.williamssound.com/registration.html>

This information will help us serve you better in the future. Thank you.

SYSTEM SPECIFICATIONS

Personal PA T35 Transmitter

Dimensions, Weight:	8.45" (21.5 cm) W x 8.18" (20.8 cm) D x 1.72" (4.4 cm) H, 3.1 lbs. (1.4 kg)		
Color:	Black with white legends		
Rack Mount:	One EIA rack space high, 1/2 space wide 1-2 units can be mounted in a single rack space with optional RPK 005 (single) or RPK 006 (double) Rack Mount Kits		
Power:	Wall mount Class II transformer (TFP 016) Input: 120VAC, 60Hz, 17W Output: 24VAC, 500mA with 3-pin Molex® plug Approvals: UL, CSA listed		
FCC ID:	CNMT35		
Temperature Range:	Operating: 0°C to 40°C (+32°F to +104°F) Storage: -20°C to 70°C (-4°F to +158°F)		
Operating Freqs:	72.1-75.9 MHz, 10 wideband channels (selectable), 7 non-standard wideband channels (selectable) OR 72.025 - 75.975 Mhz, 77 narrowband channels (selectable)		
Frequency Accuracy:	±.005% stability, 0-50° C		
Deviation:	Wideband: ± 75 kHz maximum. Narrowband: ± 5kHz maximum		
Pre-Emphasis:	Wideband: 75 µsec, Narrowband: 300 µsec		
RF Field Strength:	Does not exceed 8 mV/m at 3 m		
Note:	Maximum transmitter range is achieved using the ANT 005 coaxial antenna		
Nominal Range:	300-500 ft. (90-150 m)		
Audio Proc. Functions:	Reduced or Normal Compressor Gain Compression Slope Control High Pass and Low Pass Filter Frequency control		
Frequency Response:	22 - 16000 Hz, +1, -3 dB (adjustable)		
Signal to Noise Ratio:	74dB (transmitted)		
Audio Level Control:	Push-button audio level controls, adjustable to 0 to -50dB		
Audio Level Indicators:	10 LED array that reads +9 to -18 at 3dB intervals		
Power On Indicator:	Green LED indicates power on		
Phones Output:	Mono signal, 1/4" TRS stereo jack, 67mW, maximum in 50 ohms (adjustable 0 to -40dB)		
Audio Input:	Combination 3-pin XLR, 1/4" TRS jack		
Line Output:	RCA jack, -10dBV (.32VRMS) output, impedance 100 Ω		
LCD Menu Controls: (Push-button selection)	Applications Presets (Music, Voice, Hearing Assist) Bandwidth, Frequency, Audio Input Source (Microphone, Line, Simplex), High Pass Filter, Low Pass Filter, Compressor Slope, Compressor Gain, RF Output Power.		
Input Levels (Bal or Unbal):	<u>Nominal</u> (1st Amber LED)	<u>Maximum</u> (Input Overload LED)	<u>Absolute Maximum Ratings</u> ¹
Microphone Simplex-Mic:	-60dBV (1mVRMS)	-20dBV (100mVRMS)	+20dBV (10.0VRMS)
Line:	-8dBV (400mVRMS)	+16dBV (6.3VRMS)	+20dBV (10.0VRMS)
Simplex Mode:	12 volts simplex power (DIN 45596) on the 3-pin XLR connector		
RF "Off" Timer:	Turns off RF signal after 1 hour of no audio activity		
Common Mode Rejection:	Mic or Line > 57dB @ 1kHz		
Total Harmonic Distortion:	< 0.25% @ -10dBV audio line output, 1kHz		
Warranty:	Five Years, Parts and Labor 90 days on cords, antenna, power supply and accessories		

SPECIFICATIONS SUBJECT TO CHANGE WITHOUT NOTICE.

¹Notes: Stresses above these ratings may cause permanent damage. Exposure for extended periods may degrade reliability.

Personal PA R30 Wideband Receiver

Dimensions:	3-5/8" L x 2-3/8" W x 7/8" H (92.1 mm x 60.3 mm x 22.2 mm)
Weight:	4.6 oz (130 g) with batteries
Color:	Gray
Battery Type:	Two (2) AA 1.5 V non-rechargeable Alkaline batteries (BAT 001), 14 mA nominal current drain, 80 hours approx. life (OR) Two (2) AA 1.5 V NiMH rechargeable batteries (BAT 026), 14 mA nominal current drain, 50 hours per charge approx., recharges in 14-16 hours, uses CHG 1600 Charger or CHG 200 Charger
FCC ID:	CNM R30
Industry Canada Cert.:	13601021234
Operating Freq.:	Pre-Tuned, Adjustable, 72 MHz - 76 MHz
Intermediate Freq.:	75 kHz
FM Deviation:	75 kHz
De-Emphasis:	75 μ S
AFC Range:	\pm 120 kHz
Sensitivity:	4 μ V at 12 dB Sinad
Input Overload:	20 mV
Frequency Response:	100 - 10 kHz, \pm 3 dB
Signal-to-Noise Ratio:	65 dB at strong signal condition
Receive Antenna:	Integral with earphone/headphone cord
Audio Output:	35 mW, max. at 16 Ω
Output Connector:	3.5 mm mono phone jack
Earphone:	Earbud-type with foam cushion, 3.5 mm plug, 32 Ω
Warranty:	Five Years, Parts and Labor.
Notes:	90 days on cords, earphones, headphones, batteries and other accessories The R30 Receiver can be field tuned to any of 10 wideband channels using the PLT 005 Tuning Tool.

Personal PA R7-4 Wideband Receiver

Dimensions:	3-5/8" L x 2-3/8" W x 7/8" H (92.1 mm x 60.3 mm x 22.2 mm)
Weight:	3.2 oz (90 g) with battery
Color:	Gray
Battery Type:	9 Volt, Eveready 216 Carbon, Eveready 522 Alkaline, or BAT 003 Ni-Cad Rechargeable
Battery Drain:	14 mA, nominal
Battery Life:	32 hours with Eveready 522, 6 hours/charge with BAT 003
FCC ID:	CNM R7Y, CNM R74Y
Operating Freq.:	4-Channel, Pre-Tuned, Selectable CH A (72.1 MHz), CH C (72.5 MHz), CH E (72.9 MHz), CH G (75.7 MHz) (OR) CH B (72.3 MHz), CH D (72.7 MHz), CH F (75.5 MHz), CH H (75.9 MHz)
Intermediate Freq.:	75 kHz
FM Deviation:	75 kHz
De-Emphasis:	75 μ S
AFC Range:	\pm 300 kHz
Sensitivity:	2 μ V at 12 dB Sinad with squelch defeated
Input Overload:	20 mV
Squelch:	Squelches at 10 μ V for minimum 50 dB S/N ratio
Frequency Response:	100-10 kHz, \pm 3 dB
Signal-to-Noise Ratio:	65 dB at strong signal condition
Receive Antenna:	Integral with earphone/headphone cord
Audio Output:	250 mW, max. at 16 Ohms
Output Connector:	3.5 mm mini phone jack, also serves as a charging jack for rechargeable battery
Earphone:	Earbud-type with foam cushion, 3.5 mm plug, 32 Ω (Other styles available)
Channel Selector:	4-position, rotary switch
Warranty:	Five Years, Parts and Labor. 90 days on cords, earphones, headphones, batteries and other accessories

Personal PA Receiver Models R19 and R19-6

Model PPA R19:	2-Channel, Pre-Tuned, Selectable CH 36 (72.9 MHz), CH 66 (75.7 MHz) standard 10 Channels Available (72.1-75.9 MHz)
Model PPA R19-6:	6-Channel, Pre-Tuned, Selectable CH 4 (72.1 MHz), CH 20 (72.5 MHz), CH 36 (72.9 MHz), CH 66 (75.7 MHz) CH 43 (74.7 MHz), CH 50 (75.3 MHz)
Dimensions:	3-5/8" L x 2-3/8" W x 7/8" H (92.1 mm x 60.3 mm x 22.2 mm)
Weight:	3.2 oz (90 g) with battery
Color:	Neptune Blue
Battery Type:	(2) BAT 001 AA Alkaline or (2) BAT 026 NiMH
Battery Drain:	20 mA, nominal
Battery Life:	90-100 hrs with 2 AA Alkaline 45-50 hrs/charge with BAT 026
Operating Freq:	Crystal controlled. See factory for frequency changing instructions.
Intermediate Freqs:	10.7 MHz, 455 kHz
FCC ID:	CNMR19
Earphone:	Earbud-type with foam cushion, 3.5 mm plug, 32 Ω
Output Connector:	3.5 mm mini phone jack
FM Deviation:	Narrow-band, 5 kHz
De-Emphasis:	300 μ S
Sensitivity:	0.7 μ V at 12 dB Sinad
Squelch Level:	4 μ V for minimum 40 dB S/N ratio
Frequency Response:	100 - 5 kHz, \pm 3 dB (Tone: Lo)
Receiver Antenna:	Integral with earphone cord
Signal-to-Noise Ratio:	50dB
Audio Output:	125 mW, max. at 32 Ω (Tone: Lo; 3 VDC Bat.)
Acoustic Output:	125 dB Max SSPL90 with EAR 013

CONTROLS

Tone:	Switched Low-Cut Lo: 20 Hz / Mid: 120 Hz / Hi: 700 Hz
Volume & On/Off:	Combination, integral
Channel Selector:	PPA R19: 2-position, slide switch PPA R19-6: 6-position, rotary switch
Warranty:	Five Years, Parts and Labor. 90 days on cords, earphones, headphones, batteries and other accessories



www.williamssound.com